



# ISLANDS *Kontakt*

**SPECIAL # 20 – Edinburgh TWIN-ARC POSTMARKS WITH STAMPERS NUMBER –V1 2024**  
Compiler: Jakob S. Arrevad: [jsa@agadvokatfirma.dk](mailto:jsa@agadvokatfirma.dk).

This is a part of a series published online which summarizes, supplemented by recent discoveries, information published over the years in IslandsKontakt and elsewhere. We must all be grateful for the sustained efforts of all those who, over the years, as Editors or Authors have contributed to the gathering and dissemination of information relevant to the philately of Iceland. I have received inspiration and many copies especially from Robin Morton in respect of bar-cut and from Harald Thoma – and criticism from Ebbe Eldrup.

The goal is to describe and show the different twin-arc cancellation - with stampers number - from Edinburgh on mail from Iceland. I know it is impossible so mail from other locations are also used trying to give “the total picture”. Your copy will get me closer to that goal.

<b>EDINBURGH TWIN-ARC POSTMARKS WITH STAMPERS NUMBER .....</b>	<b>4</b>
TYPE 1.....	4
TYPE 2.....	5
TYPE 3.....	6
<b>Stampers number 1 .....</b>	<b>7</b>
Type 1 .....	7
Type 2 .....	8
Type 3 .....	8
<b>Stampers number 2.....</b>	<b>11</b>
Type 1 .....	11
Type 2 .....	12
Type 3 .....	12
<b>Stampers number 3.....</b>	<b>13</b>
Type 1 .....	13
Type 2 .....	13
Type 3 .....	14
<b>Stampers number 4.....</b>	<b>16</b>
Type 1 .....	16
Type 2 .....	18
Type 3 .....	18
<b>Stampers number 5.....</b>	<b>21</b>
Type 1 .....	21
Type 2 .....	21
Type 3 .....	21
<b>Stampers number 6.....</b>	<b>23</b>

Type 1 .....	23
Type 2 .....	23
Type 3 .....	23
<b>Stampers number 7 .....</b>	<b>27</b>
Type 1 .....	27
<b>Type 2 .....</b>	<b>27</b>
Type 3 .....	27
<b>Stampers number 8 .....</b>	<b>29</b>
Type 1 .....	29
Type 2 .....	29
Type 3 .....	29
<b>Stampers number 9.....</b>	<b>32</b>
Type 1 .....	32
Type 2 .....	32
Type 3 .....	32
<b>Stampers number 10 .....</b>	<b>34</b>
Type 1 .....	34
<b>Type 2 .....</b>	<b>35</b>
Type 3 .....	35
<b>Stampers number 11.....</b>	<b>38</b>
<b>Type 1 .....</b>	<b>38</b>
Type 2 .....	38
Type 3 .....	38
<b>Stampers number 12 .....</b>	<b>42</b>
Type 1 .....	42
<b>Type 2 .....</b>	<b>42</b>
Type 3 .....	42
<b>Stampers number 13 .....</b>	<b>46</b>
<b>Type 1 .....</b>	<b>46</b>
<b>Type 2 .....</b>	<b>46</b>
Type 3 .....	46
<b>Stampers number 14 .....</b>	<b>49</b>
Type 1 .....	49
Type 2 .....	50
Type 3 .....	50
<b>Stampers number 15 .....</b>	<b>52</b>
Type 1 .....	52
Type 2 .....	52
Type 3 .....	52
<b>Stampers number 16 .....</b>	<b>54</b>
<b>Type 1 .....</b>	<b>54</b>
<b>Type 2 .....</b>	<b>54</b>
Type 3 .....	54
<b>Stampers number 17 .....</b>	<b>57</b>
Type 1 .....	57
Type 2 .....	58
Type 3 .....	58
<b>Stampers number 18 .....</b>	<b>61</b>
<b>Type 1 .....</b>	<b>61</b>
<b>Type 2 .....</b>	<b>61</b>
Type 3 .....	61
<b>Stampers number 19 .....</b>	<b>63</b>
<b>Type 1 .....</b>	<b>63</b>
<b>Type 2 .....</b>	<b>63</b>
Type 3 .....	63

<b>Stampers number 20</b> .....	<b>65</b>
<b>Type 1</b> .....	65
<b>Type 2</b> .....	65
Type 3 .....	65
<b>Stampers number 21</b> .....	<b>68</b>
Type 1 .....	68
Type 2 .....	69
Type 3 .....	69
<b>Stampers number 22</b> .....	<b>73</b>
Type 1 .....	73
<b>Type 2</b> .....	73
Type 3 .....	73
<b>Stampers number 23</b> .....	<b>75</b>
Type 1 .....	75
<b>Type 2</b> .....	76
Type 3 .....	76
<b>Stampers number 24</b> .....	<b>77</b>
Type 1 .....	77
<b>Type 2</b> .....	77
Type 3 .....	77
<b>Stampers number 25</b> .....	<b>79</b>
<b>Type 1</b> .....	79
<b>Type 2</b> .....	79
<b>Type 3</b> .....	79
<b>Stampers number 31</b> .....	<b>81</b>
<b>Type 1</b> .....	81
<b>Type 2</b> .....	81
Type 3 .....	81
<b>Stampers number 32</b> .....	<b>83</b>
<b>Type 1</b> .....	83
<b>Type 2</b> .....	83
Type 3 .....	83
<b>Stampers number 33</b> .....	<b>87</b>
<b>Type 1</b> .....	87
<b>Type 2</b> .....	87
Type 3 .....	87
<b>Stampers number 34</b> .....	<b>90</b>
<b>Type 1</b> .....	90
<b>Type 2</b> .....	90
<b>Type 3</b> .....	90
<b>No number - but "cut"</b> .....	<b>92</b>
<b>No number – no "cut"</b> .....	<b>94</b>
<b>Cross pattée</b> .....	<b>97</b>
<b>References:</b> .....	<b>98</b>

# EDINBURGH TWIN-ARC POSTMARKS WITH STAMPERS NUMBER<sup>1</sup>

Edinburgh is a central port in the history of mail from Iceland and a great deal of the Edinburgh cancellations on Icelandic mail is done with a “twin-arc postmark”. This study includes all postmarks even if they are not known used on mail from Iceland – but:

*"It is suspected that many other examples of these twin-arc stamps may have been produced in the early 1920s and readers are asked to check their collection."*

According to James A. Mackay<sup>2</sup> Twin-arc postmarks were introduced in Scotland 19 January 1883 for Edinburgh and entered in the Kirkwood proof book with the text “First combined stamp”, but the following copy from Kirkwood is probably not used – but it is the father of:

## TYPE 1.



In the Kirkwood proof book, it was followed by:



The first day of use is uncertain, but I have MR 27 83.

The number at left over the date is in this type the stampers number

The stampers number is the first figure in my categorizing system – here 1 and the second is the type here 1 and the last figure is the under type.

The following example is with stampers number 10 – type 1 and it is under type 1 – so: 10.1.1

---

<sup>1</sup> Drawings are mostly copies from Mackay; “Scottish Twin-Arc Postmarks” (1983)– copies from Kirkwood Prof Book (The proofs in Kirkwood are sometime unclear, for example around 1900). Copies from Kirkwood are described with “Proof”. Mackays drawings are mostly done on the basis of Kirkwood. Copies are – if possible - Icelandic mail not specific mine but also from friends, auction catalogs and different magazines.

<sup>2</sup> Most of the historical information based on James A. Mackays work from 1983 and supplemented with information in "Scottish combined datestamps with stampers' numbers – a postal history exhibit" by Jack A. Gunn and Alastair J. Gunn (2012) – referred to as "Gunn"



The significance for type 1 is Edinburgh's town number - 131 - between the twin-arcs.

It began with one letter for the time (\* on the first proof) – called "Double Code Combined Stamp." Used until January 1895 when changed to the following type 3.

There are the following different versions:

x.1.1 – with thin arcs

x.1.2 – with fat arcs

x.1.3 – with bar cuts used with stampers number 1, 2, 3, 4, 6, 10, 12, 17, 21 and 23 and with no number. There exists a proof of number 24 but no use seen.<sup>3</sup>

To finalize the systematic system, there is a fourth figure used on type 3 indicating that the stamp is unchanged except that the date changes from 31 DE 1913 to JA 14 – example 5.3.6.1 – stampers number 5, type 3, under type 6 and under, under type change of the dating system.

## TYPE 2.

A "Treble Code Combined Stamp" (with a letter and a number or two letters right of the stampers number) was in use from February 19, 1891 until probably mid-August 1894.

<sup>3</sup> Auckland, A. Bruce; "The Edinburgh Bar Cuts" (Postal History Society Bulletin no. 142)  
 Aitchison, Ian M.; Th Edinburgh Bar Cuts (Catalogue of the Edinburgh 77 Philatelic Exhibition)  
 Morton, Robin and Arrevad, Jakob; "Edinburgh 2AM Barcut", "The Scottish Post" 2019 no. 161 page 9-10  
 Parkin, Stephen RH; "Edinburgh Double Barcut" "The Scottish Post" 2019 no. 162 page 4-5  
 Morton, Robin: The Bar Cut Postmarks of Edinburgh 1887-1904. The London Philatelists 2020 p. 477



To Edinburgh's town number was added two stars (\*131\*) between the arcs. They were used for cancelling mail in the Head Office "box"<sup>4</sup>. The use properly stopped due to a change in the proceedings at the Head Office "box".

It exists with stampers number 1, 4, 5, 6, 7, 8, 9, 10, 11, , 13, 14, 15, 16, 17 and 21. Perhaps 32, 33, 34 – and the missing numbers too.

### TYPE 3.

From January 1895, the stamps show the hour and minute over the date. 131 was removed and replaced by the stampers number.



These two examples (1.3.1 and 6.3.1) are with bar cuts<sup>5</sup> known with the stampers number 1, 6, 10, 12, 17 and 21 – and with no stampers number (type 34)

The rest is with unbroken arcs – as this example 2.3.1:



6





<sup>4</sup> Auckland, A. Bruce; "The Edinburgh Bar Cuts" (Postal History Society Bulletin no. 142)

<sup>5</sup> See note 3

<sup>6</sup> The measuring's are inaccurate in drawings and copies. The size when mentioned is described as accurate as possible based on the proof book and examples, but rubber stamps are always difficult to measure.

# Stampers number 1

## Type 1



My no <sup>7</sup> :	Ref. <sup>8</sup>	Proof and drawings from Mackay to the left – examples to the right
1.1.1		<div style="display: flex; justify-content: space-around; align-items: flex-start;"> <div style="text-align: center;">  <p>proof MR 30 83</p> </div> <div style="text-align: center;">  <p>I have MR 27 83 - 3 days before</p> </div> </div>
1.1.2		<div style="text-align: center;">  <p>proof DE 4 90</p> </div>
1.1.3		<div style="display: flex; justify-content: space-around; align-items: flex-start;"> <div style="text-align: center;">  <p>proof SP 15 91 with bar cut</p> </div> <div style="text-align: center;">  </div> </div> <p>There are further entries in Kirkwood from NO 9 93, NO 7 94 and NO 21 1995 with no text.<sup>9</sup>  My latest is from FE 22 94.  Aitchison/Robin Morton: Recorded use 3 December 1891- 19 August 1894 – but Morton also show use OC 30 91</p>

<sup>7</sup> The first figure is "the Stampers number", the second is the type and the third is an ongoing number within the "group".

<sup>8</sup> It is the number given by James A. Mackay in his book – only describing type 3.

<sup>9</sup> The proof from 1895 is strange – as seen under type 3 (1.3.1) the stamp was altered JA 22 95. I cannot give an explanation.

## Type 2



1.2.1		<p>Auckland shows it and it is in Kirkwood but I have no example.</p> <div style="display: flex; justify-content: space-around;"> <div style="text-align: center;">  <p>Proof Auckland MY 12 91 –</p> </div> <div style="text-align: center;">  <p>Kirkwood MY 2 92</p> </div> </div>
-------	--	---

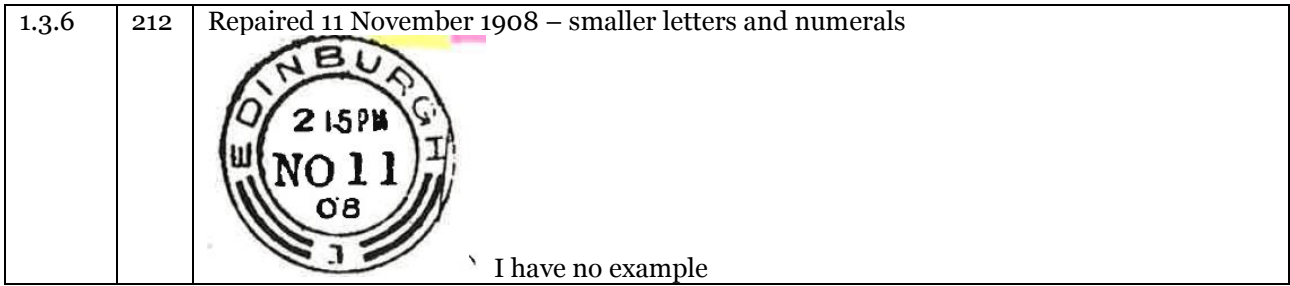
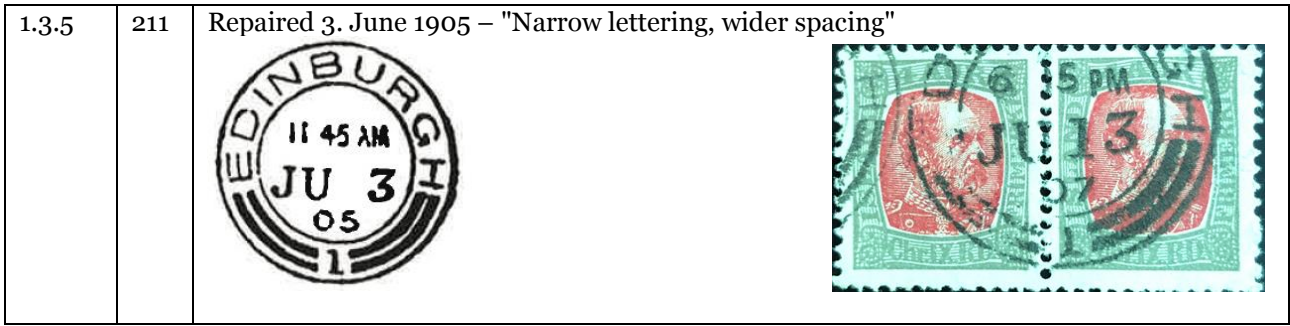
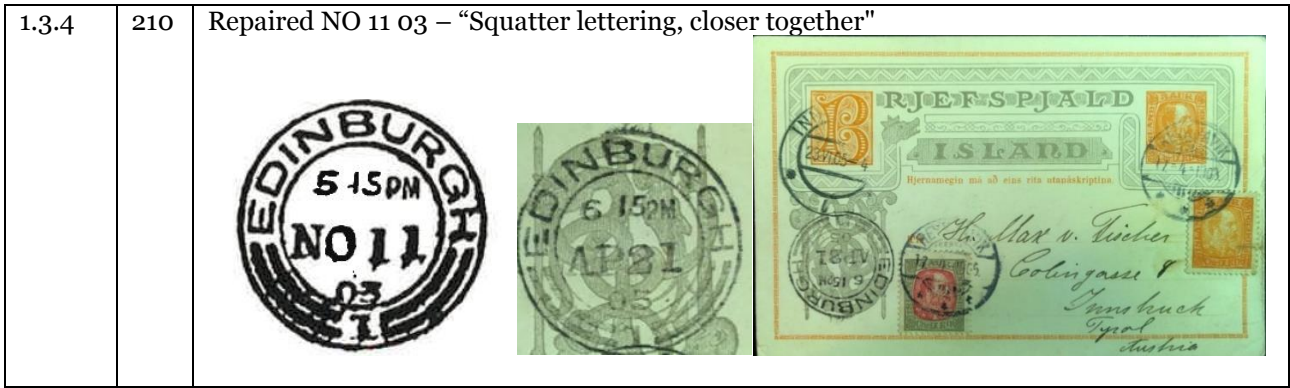

## Type 3

1.3.1	207	<p>Original stamp (1.1.3) converter for clock time JA 22 95; still bar cut in outer arcs</p> <div style="display: flex; justify-content: space-around;"> <div style="text-align: center;">  <p>Aitchison/Robin Morton: Recorded use 6 December 1895 – 21 January 1896</p> </div> <div style="text-align: center;">  </div> </div>
1.3.2	208	<p>New case DE 10 96 – 28 mm in diameter</p> <div style="display: flex; justify-content: space-around;"> <div style="text-align: center;">  </div> <div style="text-align: center;">  <p>The card is written on board SS Laura in islandic.</p> </div> </div>
1.3.3	209	<p>New case 2 October 1900 – 29 mm (Gunn 30 mm) in diameter large month and day</p> <div style="display: flex; justify-content: space-around;"> <div style="text-align: center;">  <p>Proof OC 2 00</p> </div> <div style="text-align: center;">  <p>Not damaged</p> </div> <div style="text-align: center;">  <p>Damaged MR 28 03</p> </div> <div style="text-align: center;">  <p>Late use OC 1 03</p> </div> </div>





1.3.7	213	Repaired 5 April 1911 – 'E' has a short middle bar	 
-------	-----	--	--

1.3.7.1		Change dating system 1 January 1914 The use ends in 1930 rather worn out. 'E' with equal middle bars and the two bars are almost one – see the difference between left and right side.	 
---------	--	---	--

# Stampers number 2

## Type 1

2.1.1	I have not seen it with thin arces
2.1.1.1?	<p>It looks like there has been one before 2.1.2 – but not with thin arces. No proof .</p> <div style="display: flex; justify-content: space-around;">   </div>
2.1.2	<div style="display: flex; justify-content: space-around;"> <div data-bbox="351 851 758 1198"> <p><i>New Type 2.</i></p>  <p>proof JA 23 91</p> </div> <div data-bbox="1173 851 1428 1198">  <p>JU 30 91 - 5<sup>th</sup> trip Reykjavik Copenhagen SS Thyra</p> </div> </div>
2.1.3	<div style="display: flex; justify-content: space-around;"> <div data-bbox="351 1265 758 1534">  <p>proof SP 15 91 with bar cut Aitchison/Robin Morton: Recorded use 7 October 1891- 1 July 1895 – but he also shows SP 16 91 – and there exists JY 29 1895:</p> </div> <div data-bbox="574 1646 1428 1921">  </div> </div>

## Type 2

		I have not seen it
--	--	--------------------

## Type 3



2.3.1	214	Issued 29 August 1895 – 28. mm	 
2.3.2	215	Repaired 30 June 1899 – 29 mm	 
2.3.2.1		I am not sure it is a new version.	   <p>Proofs from 1901.</p> <p>It doesn't look new?</p>
2.3.3	216	Repaired 16 August 1902 - 27 mm. I have not seen # 2 used again before 1926!	 



2.3.3.1		New dating system – first use after 1905	
---------	--	--	---

### Stampers number 3

#### Type 1

3.1.1		I have not seen it with thin arcs - either as proof or real	
-------	--	---	--

3.1.2		 <p>Proof DE 8 90</p>	
-------	--	---	---

3.1.3		 <p>Proof SP 15 91 Aitchison/Robin Morton: Recorded use 9 November 1891- 8 June 1895 – but Morton has recorded use SP 17 91 Robin Morton shows a worn stamp with an extended lover left-hand bar from JY 23 94</p>	
-------	--	---	--

#### Type 2

3.2.		I have not seen it	
------	--	--------------------	--

**Type 3**

3.3.1	217	Issued 20 August 1895 – 29 mm – long arcs	
-------	-----	---	--

3.3.2	218	Repaired 11 August 1902 – shorter arcs – apparently only used for a short 1902-1905 – and the again after 1 JA 14.	
-------	-----	--	--

3.3.2.1		<p>Change dating system 1 January 1914 – but not used until end 1920's?</p> <div style="display: flex; justify-content: space-around; align-items: flex-start;"> <div style="text-align: center;">  <p>Used up to 1930</p> </div> <div style="text-align: center;">  <p>(31 JU 30) A colorful example.</p> </div> </div>
---------	--	---

# Stampers number 4

## Type 1

4.1.1		I have not seen it either as proof or real
4.1.2		  <p>Proof - probably not used as it was altered 4 days later (4.1.3.1) No letter after 4</p>
4.1.3.1	10	 <p>Proof – probably not used</p>
4.1.3.2		<p>But in the real world; note – that the cut was changed from the outer arc to the inner. Next step might be the following example from OC 8 91 and NO 16 91 without a letter after “4”</p> 

<sup>10</sup> Aitchison/Robin Morton state the “recorded use” aog the bar cut stamps as: “31 OC 1891 – 3 OC 1895 for type 4.1.3 all together

<sup>11</sup> Auckland, A. Bruce; “The Edinburgh Bar Cuts” (Postal History Society Bulletin no. 142) fig. 5, Robin Morris shows as figure 13



4.1.3.3

Soon – already in early 1892 - the outer ring is lost (removed) but it is still the same stamp



<sup>12</sup>



<sup>13</sup>

But reentered in the proof book in 1894 with the change



and again in 1895



Used up to 3th October 1895

<sup>12</sup> Same but fig. 6

<sup>13</sup> Robin Morton fig 14

## Type 2

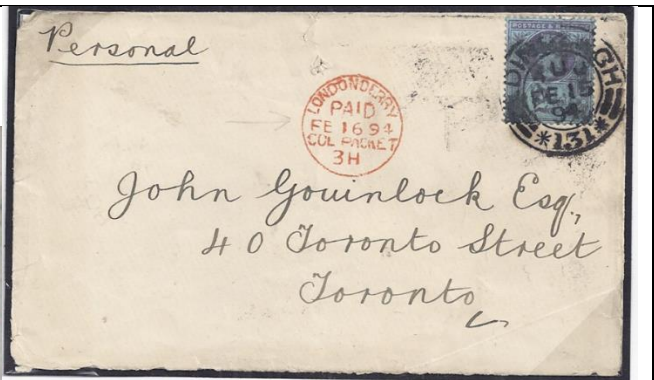
4.2.1			
-------	--	---	--

## Type 3



4.3.1	219	13 November 1895 – 28 mm	
-------	-----	--------------------------	---

4.3.2	220	  	
-------	-----	--	--



4.4.3	221	New case 5 March 1901 – 29 mm diameter	
-------	-----	--	--

4.4.4	222	Repaired 5 December 1903 – Squatter lettering, thicker arcs	
-------	-----	---	--

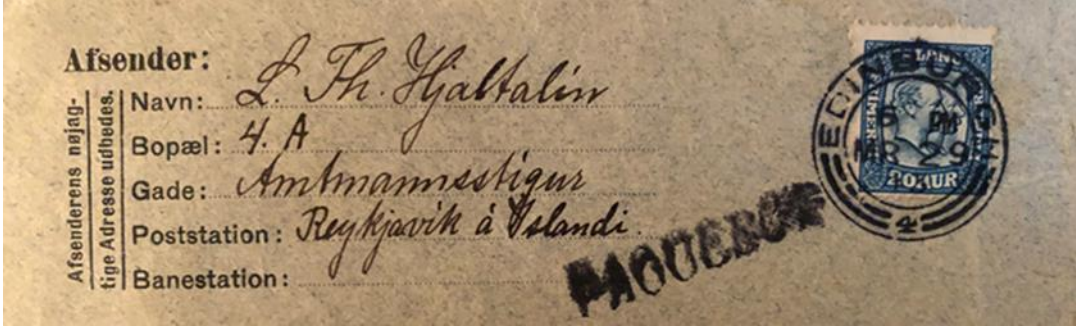
4.4.5	223	New case 6 June 1906 – 26 mm diameter	
-------	-----	---------------------------------------	--

4.4.6	224	<p>New case 27 February 1909 – 27 mm diameter, longer and thinner arcs</p>   
-------	-----	--

4.4.6.1		<p>Change dating system 1 January 1914 ? but not immediately on the stamp:</p> 
---------	--	---



4.4.7	225	<p>New 9 case September 1914 – 27 mm diameter, taller lettering.</p>  
-------	-----	---

## Stampers number 5

### Type 1

5.1.1		I have not seen it either as proof or real
5.1.2		I have not seen it either as proof or real
5.1.3		It doesn't exist

### Type 2

5.2.1		 
-------	--	--

### Type 3



5.3.1	226	<p>Issued 8 March 1895 – 28 mm diameter</p>  
5.3.2	227	<p>Repaired 1 June 1899 – shorter 'E' and 'R'.</p>  <p>I don't have an example.</p>
5.3.3	228	<p>New 21 August 1900 – 29 mm diameter, larger lettering</p>  

5-3.4	229	Repaired 5 October 1904 – different 'R', thicker arcs	
5-3.5	230	New 7 April 1906- 28 mm diameter, closer arcs.	
5-3.6	231	New 13 March 1911 25 mm diameter	
5-3.6.1	Change dating system 1 January 1914		 <p>Used at least until 1923</p>

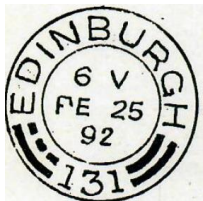

# Stampers number 6

## Type 1



6.1.1		I have not seen it either as proof or real with thin arches
6.1.2		I have not seen it whid fat arces either as proof or real
6.1.3		Used from January 1892 with bar cut – draving FE 25 92 from Auckland: Aitchison/Robin Morton: Recorded periode of use 25 Februar 1892 – JA 4 1895 -but here in 1892, and I have an UK stamp from JA 95

## Type 2

6.2.1		 
-------	--	--

## Type 3

6.3.1	232	<p>Original stamp converted to clock time 23. 1.1895 – two cuts in inner left arc. Per Auckland, A. Bruce “23” was changed to “6” (6.3.1)</p> <div style="display: flex; justify-content: space-around; margin-top: 10px;">   </div> <p>Proof Aitchison/Robin Morton: Recorded use from 24 January 1895</p> <p>From 1896 and to the end the frame in the bottom near “6” slowly disappear.</p>
-------	-----	---

6.3.2	233	<p>Same repaired 4.6.1897; arcs closer to "6" but still with bar cut. "timer" changed.</p> 
6.3.3	234	<p>Same repaired 10.1.1898 "15-minute system"</p>  
6.3.4	235	<p>Same repaired again 8.5.1901 – thicker arcs.</p>  
6.3.5	236	  <p>Aitchison/Robin Morton: Recorded use until 12 January 1904 -here FE 23 04</p>



6.3.6	237	<p>New case (not shown in the proof book) 28 mm diameter. Thick arc. No bar cut</p>  <p>In use before the date mentioned by Mackay (December 1904). I have the shown AP 7 04 on an English postmark. In 1906 it was used on the back of this letter send with s/s "KONG TRYGVE"</p> <p>Here in 1910:</p> 
6.3.7	238	<p>New case 3.2.1911. 26 mm. Smaller lettering and numeral</p>  <p>Known without time</p> 



<sup>14</sup> The \* in Mackay's drawing show, that it is not found in Kirkwood.

6.3.7.1		Change dating system 1 January 1914.	
---------	--	--------------------------------------	--

6.3.7.2		<p>New stamp or ? Thinner and longer arcs space between E and D – “D” more like an O: I have these two examples from 1922 and 1929:</p>	 <p>(The 50 aur stamp is position 11; "Falling rock")</p>
---------	--	---	--

# Stampers number 7

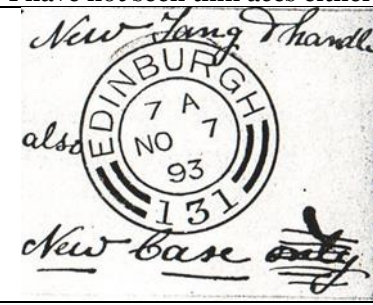



## Type 1

7.1.1		I have not seen thin aces either as proof or real	
7.1.2			
7.1.3		It doesn't exist	

## Type 2

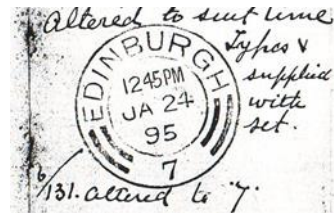
7.2.1			
-------	--	--	--

## Type 3

7.3.1	239	<p>Reverted to clock time and *131* replaced by stampers number – Hour and minutes 1995</p> 	
7.3.2.	240	<p>New case 2 November 1897. Broader lettering, longer arcs. 28 mm.</p> 	

7.3.3	241	<p>Repaired 4 October 1902. Thicker outer arcs, broader lettering</p>   <p>The cancellation KOLFERYJUSTADUR is special – but similar postcards from the same day exist. The address is the office of THORE LINE.</p>
7.3.4	242	<p>Repaired 10 April 1905. Longer arcs, narrower lettering.</p>  
7.3.5	243	<p>New case 23 March 1911. 25-6 mm diameter</p>  
7.3.5.1		<p>Change dating system 1 January 1914?</p> 

# Stampers number 8

## Type 1

8.1.1		I have not seen it either as proof or real
8.1.2		I have not seen it either as proof or real – but see the text on the 8.2.1 proof
8.1.3		It doesn't exist

## Type 2



8.2.1		<p><i>New case Tong + handle</i></p> <p>EDINBURGH 8 5 1 SP 4 9 1 *131*</p> <p><i>Types completely repaired</i> <i>New types B.D.F.J.R.S.T.W.5.6.13.</i> <i>Dates types 1.3.</i></p>	Proof
-------	--	---	-------

## Type 3

8.3.1	244	Converted to clock time and stamper's number 9 November 1895	
8.3.2	245 a	Type 8.3.2 is from 29 November 1897 according to the proof book, but it is probably one year wrong. Mackay show in his supplement (page 739) 23 July 1896.	
8.3.2.1	245	“Completely repaired” 29 November 1897 – Different G and other letters – longer arches at least to the right	<p><i>Completely repaired</i></p>
8.3.3	246	Repaired 1 March 1898. 8 is bigger and longer arcs	

		<p>Used at Edinburgh Philatelic Society's homepage. Late use.</p>
8.3.4	247	<p>Repaired 24 September 1902 – squatter lettering.</p>
8.3.5	248	<p>Repaired 16 March 1906. narrower lettering and numeral longer - space between G to H</p> <p>Behind the example is a beautiful love story described in a “Christmas letter” from the late president of “Islandsklubben”, Ib Schock. The letter I send from Kaaber in Reykjavik to Faeroe Island to Miss Astrid Thomsen in May 1907 – it was followed by a letter from June 1907 to Ms Astrid Kaaber!</p>
8.3.6	249	<p>New case 1 February 1910. 27 mm diameter. Taller lettering.</p>
8.3.7	250	<p>New case 7 July 1911 28 mm diameter. Short, thick arcs</p> <p>I have no example</p>

8.3.8	251	<p>New case 25 June 1913. 23 mm diameter. Very short arcs.</p>  <p>I have no example</p>
-------	-----	---

8.3.8.1		<p>Change dating system 1 January 1914– seen used in 1926.</p>   <p>nesson D PAQUEBLOT</p>
---------	--	---

# Stampers number 9

## Type 1

9.1.1		I have not seen it either as proof or real
9.1.2		I have not seen it either as proof or real
9.1.3		It doesn't exist

## Type 2

9.2.1	9	
-------	---	---

## Type 3

9.3.1	252	<p>New stamp 10 October 1895. 28 mm diameter. Small lettering and numeral</p> 
9.3.2	253	<p>New case 22 August 1902. 30 mm diameter.</p> 







9.3.3	254	Repaired 26 March 1904? – difference?	
9.3.4	255	New case 4 September 1908. 24 mm – the arcs do not go into the 9	
9.3.4.1		Change dating system 1 January 1914	 <p data-bbox="694 1435 911 1464">I have no example</p>
9.3.5	256	New case 28 February 1918. 26 mm diameter. Long thin arcs. Seen used until 1927	

# Stampers number 10

## Type 1



<p>10.1.1</p>	<p>I have not found the first proof before production and use but stampers number 1 and 17 is from 1883</p> <div style="display: flex; justify-content: space-around; align-items: flex-start;"> <div style="text-align: center;">  <p>Proof 1885</p> </div> <div style="text-align: center;">  <p>control proof 86</p> </div> <div style="text-align: center;">  <p>control proof 89</p> </div> </div> <div style="display: flex; justify-content: space-around; align-items: flex-start; margin-top: 20px;"> <div style="text-align: center;">  <p>Used at least until DE 30 1889</p> </div> <div style="text-align: center;">  </div> </div>
<p>10.1.1.1</p>	<div style="text-align: center;">  <p><i>Completely suppressed</i></p> <p>It is difficult to see the differences.</p> </div>
<p>10.1.2.</p>	<p>No proof found</p> <div style="display: flex; justify-content: space-around; align-items: flex-start;"> <div style="text-align: center;">  </div> <div style="text-align: center;">  </div> </div>

10.1.3		 <p>Proof from 1891</p>	
		Aitchison/Robin Morton: Recorded use 23 October 1891 (before the proof) – 11 January 1895 including 10.1.3.1	
10.1.3.1		<p>I am not sure – it might be the drawing that differs?</p>  <p>Bar cut – example from Auckland</p>	 <p>OC 9 94</p>



### Type 2

10.2.1			
--------	--	--	--

### Type 3

10.3.1	257	<p>Original stamp converted 26.1.1895 in right outer arc</p>  <p>Proof</p> <p>Aitchison/Robin Morton: Recorded use 27 August 1895 – 20 October 1896 (probably including 10.3.1)</p>	
--------	-----	---	---

10.3.2	258	Same(?) but with thinner arch's from 8.6.1896 – Still one "cut" in right outer arc	
10.3.3	259	Repaired 23.7.1897 - Squatter lettering and numbers. Still one "cut" in right outer arc	 <p data-bbox="371 869 1241 898">Aitchison/Robin Morton: Recorded use 17 april 1897 to 3 March 1890</p>
10.3.4	260	New case 2.11.1900. 29 mm diameter and long, thick and sharp arcs	
10.3.5	261	New case 29.8.1903. 27 mm diameter and short arches	

10.3.6	262	Repaired 28.2.1906. 28 mm (?). Broader lettering. <div style="display: flex; justify-content: space-around; align-items: center; margin-top: 10px;">    </div>
--------	-----	--

10.3.7	263	Repaired 15.11.1909. 27 mm (see 10.6 repaired and 28 mm??) Narrow lettering. <div style="display: flex; justify-content: space-around; align-items: center; margin-top: 10px;">   </div>
--------	-----	---

10.3.7.1		Change dating system 1 January 1914. <div style="display: flex; justify-content: space-around; align-items: center; margin-top: 10px;">   </div>
----------	--	---

# Stampers number 11

## Type 1

11.1.1		I have not seen it either as proof or real
11.1.2		I have not seen it either as proof or real
11.1.3		It doesn't exist

## Type 2



11.2.1		
--------	--	---

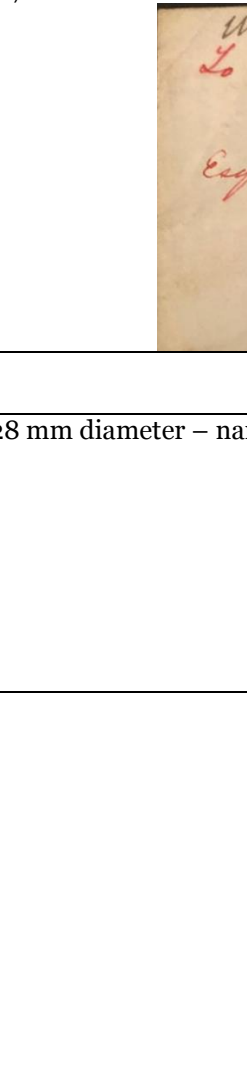

## Type 3

11.3.1	264	New case 12.3.1895 – 27 mm diameter	
--------	-----	-------------------------------------	--



11.3.2	265	New case 24.2.1898 -28 mm diameter – narrow lettering	
--------	-----	---	---

11.3.3	266	New case 17.10.1899 – 30 mm diameter	
--------	-----	--------------------------------------	--

11.3.4	267	New case 15.10.1902 – 28 mm diameter  	
--------	-----	--	---

11.3.5	268	New case 8.5.1905 – 26 mm diameter	 
--------	-----	------------------------------------	---

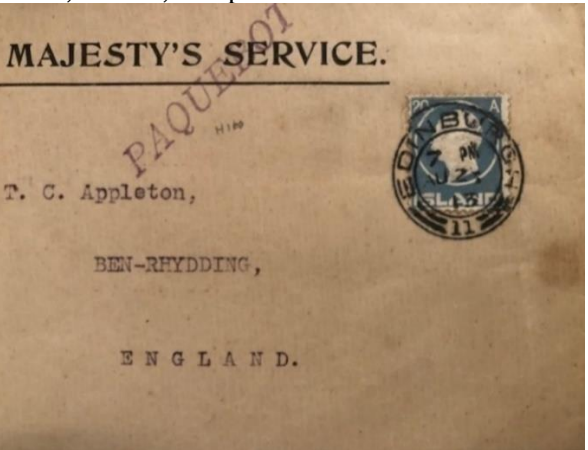

11.3.6	269	New case 22.3.1906 – 29 mm diameter	
--------	-----	-------------------------------------	--

11.3.7	270	New case 22.10.1908	 <p data-bbox="1125 952 1300 985">Late use 1911:</p> 
--------	-----	---------------------	--

11.3.8	271	New case 21.3.1911 – 25 mm diameter, thicker, sharpened arcs	
--------	-----	--	--

11.3.8.1	Change dating system - January 1, 1914 - until 25. June 2014 ??	
----------	---	--



11.3.9	272	<p>New case 25.6.1914 – 26 mm diameter, narrow lettering widely spaces used until app. 1930</p> <div style="display: flex; justify-content: space-around; align-items: center;"> <div data-bbox="406 571 630 784" style="text-align: center;">  </div> <div data-bbox="917 761 981 795" style="text-align: center;">1914</div> <div data-bbox="1037 347 1428 784" style="text-align: center;">  </div> </div> <div style="display: flex; justify-content: space-around; align-items: center; margin-top: 20px;"> <div data-bbox="917 1052 981 1086" style="text-align: center;">1927</div> <div data-bbox="1045 795 1428 1075" style="text-align: center;">  </div> </div>
--------	-----	--

# Stampers number 12

## Type 1

12.1.1		I have note see either proof or use
12.1.2		 
12.1.3		  <p>Seen without the "time letter"      Example JU 31 93  Aitchison/Robin Morton: Recorded use 7 November 1891 to 14 January 1895</p>

## Type 2

12.2.1		I have not seen it – but it should exist
--------	--	--





## Type 3

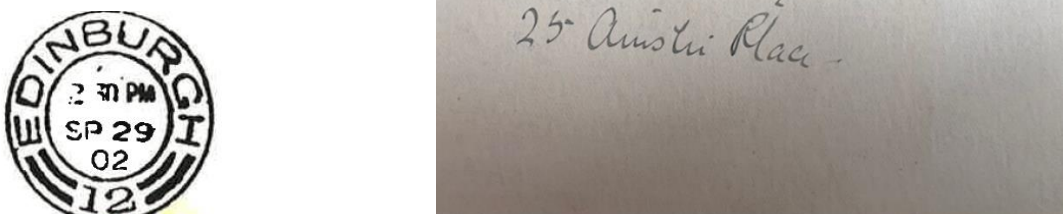

12.3.1	273	<p>Original stamp converted 28.1.1895 – Cut through both right-hand bars.</p> <p>Aitchison/Robin Morton: Recorded use 17 April 1895 – 26 September 1896</p>
--------	-----	---

12.3.2	274	New case 2.9.1896 – 28 mm diameter, longer, thinner arcs	
--------	-----	--	--

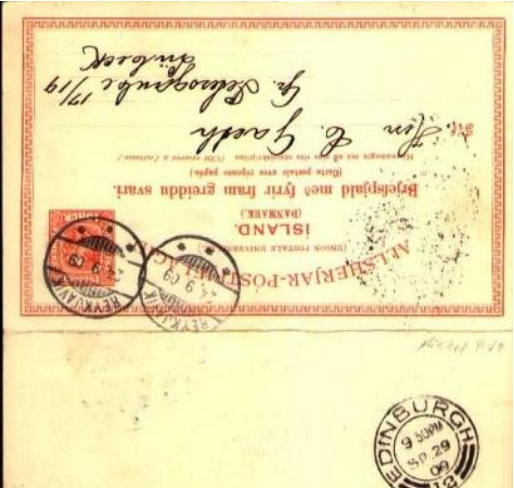
12.3.3	275	New case 2.2.1900 – 30 mm diameter, large broad lettering	
--------	-----	---	---

12.3.4	276	New case 29.9.1902 – 28 mm diameter	
--------	-----	-------------------------------------	--

12.3.5	277	Repaired 24.5.1905 'G' more rounded  	
Same day and time cancelled with stampers no. 19 – Two men at work!			
12.3.6	278	Repaired 14.1.1907 – taller lettering  	
12.3.7	279	New case 29.3.1909 28 mm, thicker arcs  	
12.3.7.1		Change dating system - January 1, 1914 And before 18 JA 16	

12.3.8	280	<p>New case 18.1.1916 – 26 mm diameter, small lettering and numerals</p> <div style="display: flex; justify-content: space-around; align-items: center;">   </div>
--------	-----	---

# Stampers number 13



## Type 1



13.1.1		I have not seen it either as proof or real
13.1.2		I have not seen it either as proof or real
13.1.3		It doesn't exist

## Type 2



13.2		I have not seen it – but it should exist
------	--	--

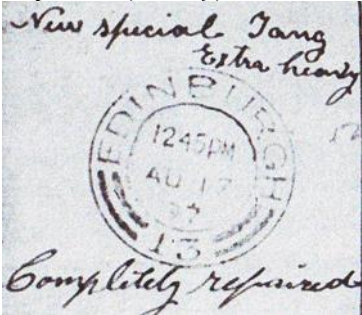

## Type 3

13.3.1	281	<p>Issued 4.3.1985 – 27 mm diameter.</p>  
--------	-----	---



13.3.2	282	<p>Repaired 17.8.1897 – shorter arcs.</p>    <p>Damaged already in December. From a letter from Edinburgh to Dresden</p>
--------	-----	--

13.3.3	283	<p>New case 30.11.1898 – 28 mm diameter.</p>  <p>I don't have examples</p>
--------	-----	---

13.3.4	284	New case 2.2.1899 – 27 mm diameter.	 
--------	-----	-------------------------------------	--

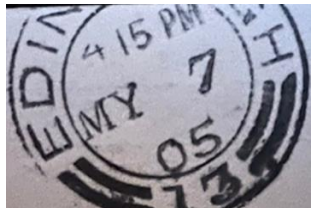
13.3.5	285	New case 20.9.1902 – 28 mm diameter.	 
--------	-----	--------------------------------------	---

13.3.6	286	New case 12.10.1904 – 29 mm diameter.	 
--------	-----	---------------------------------------	---

13.3.7	287	New case 26.2.1907 – 26 mm diameter.	 
--------	-----	--------------------------------------	--

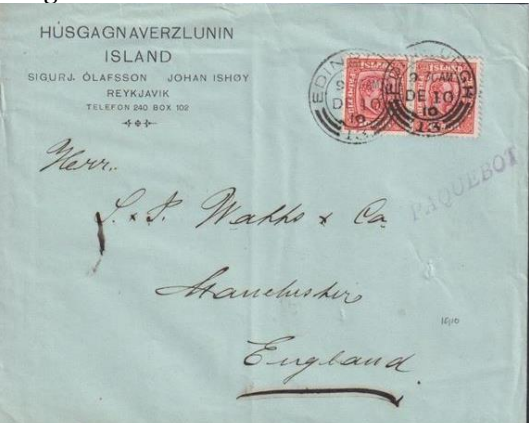
13.3.8	288	Repaired 1.4.1910 Thicker arcs, narrow lettering.	
--------	-----	---	--



13.3.9	289	New case app. 1912 ?? - after AU 6 12 – see 13.3.8 - Small numbers.	
--------	-----	---	--



13.3.9.1		Change dating system - January 1, 1914?	
----------	--	---	--

13.3.10	290	New case 8.7.1914 – 26 mm diameter, thinner arcs – 26 mm diameter.	 <p data-bbox="632 1771 858 1800">I have no examples</p>
---------	-----	--	---





# Stampers number 14

## Type 1

14.1.1		I have not seen it either as proof or real
--------	--	--

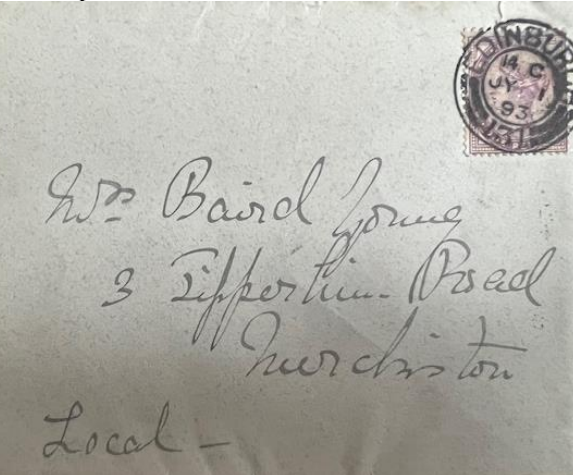
14.1.2.1		MY 12 92	
----------	--	----------	--

14.1.2.2		JY 1 93 Letters changed – I have found no proof	
----------	--	---	---

14.1.2.3		<p>Proofs – ptobably the same as 14.1.2.2.          Drawing lines from the back of “E” and from the firs “1” gives the same picture.</p>  <p><i>New Yang, only</i>          They are all identical.</p>
----------	--	---

14.1.3		I doesn't exist -no bar cuts
--------	--	------------------------------

## Type 2

14.2.1			
--------	--	---	---

## Type 3

14.3.1	291	<p>Converted stamp – changed to clock time 26 January 1895 – 25 mm diameter</p> 	
14.3.2	292	<p>New case from 22 February 1897 – 29 mm diameter – “15 minute system”</p> 	
14.3.3	293	<p>Repaired 20 November 1902 – larger, broader lettering and short, thick arcs</p> 	

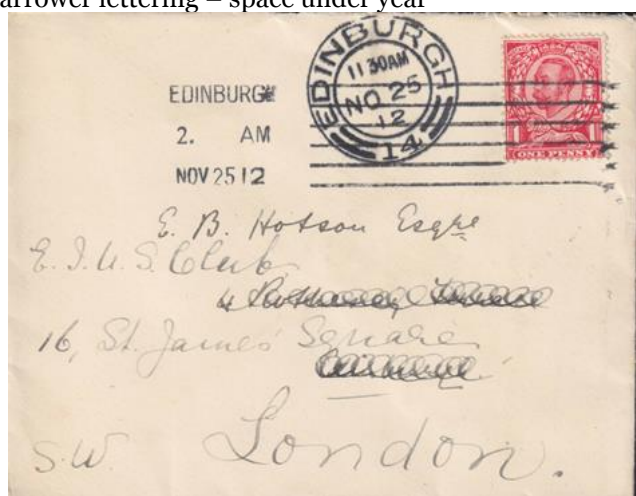
14.3.4	294	Repaired 18 March 1909 – taller, narrower lettering – space under year  
--------	-----	--

14.3.4.1		Change dating system - January 1, 1914 – seen used until 1930 Used on Scottish mail in the beginning but later in the 20 <sup>th</sup> on mail from Iceland 
----------	--	---

# Stampers number 15



## Type 1

15.1.1		I have not seen it either as proof or real
15.1.2		I have not seen it either as proof or real
15.1.3		It doesn't exist

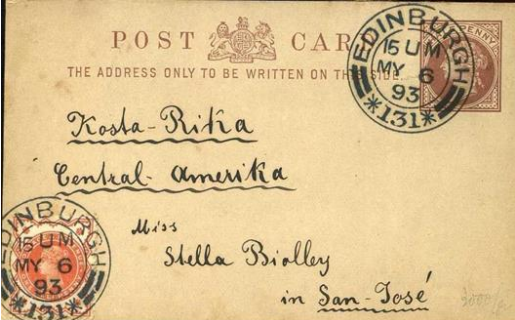
## Type 2



15.2.1		<sup>15</sup>	 
--------	--	---------------	--

## Type 3

15.3.1	295	New stamp 24 October 1895 - 28 mm diameter	  <p>on the back</p> 
--------	-----	--	--

15.3.2	296	Repaired 6 August 1902 – larger lettering and shorter, thicker arcs	 
--------	-----	---	--

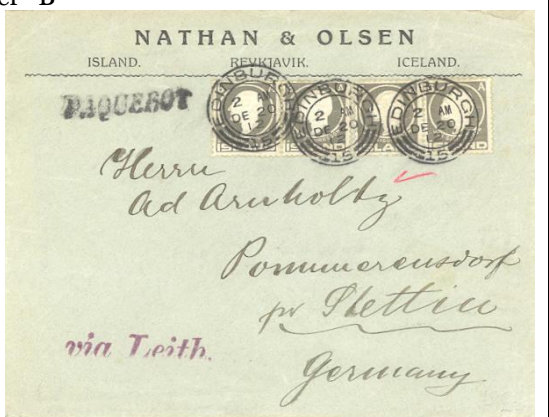

<sup>15</sup> Per Auckland, A. Bruce it don't exist – but it does.

15.3.3	297	New case from 26 October 1904 – 26 mm diameter		
--------	-----	--	---	--

15.3.4	298	Repaired 25 February 1909 – taller, narrower "B"		
--------	-----	--	--	---

15.3.5	299	New case from 22 October 1913 – 26 mm diameter		I have no examples.
--------	-----	--	---	---------------------

15.3.5.1		Change dating system - January 1, 1914?	
----------	--	---	---

15.3.6	300	New case from 1 October 1915 – 25 mm diameter.		
--------	-----	--	---	---

# Stampers number 16

## Type 1

16.1.1		I have not seen it either as proof or real
16.1.2		I have not seen it either as proof or real
16.1.3		It doesn't exist

## Type 2

16.2.1			
--------	--	--	---

## Type 3

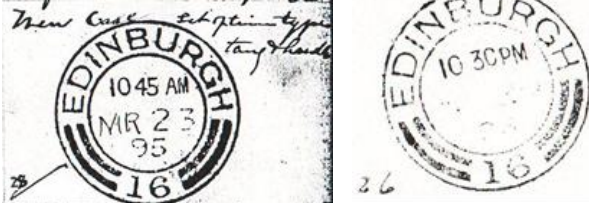
16.3.1	301	New case 23 March 1895 28 mm diameter	 <p>Proof from Kirkwood – NO 20 96</p>
--------	-----	---------------------------------------	--

16.3.1.1		Antikva – before 16.3.2	An unsolved problem	
----------	--	-------------------------	---------------------	---

6.3.1.2			 <p>Proof NO 11 97</p>
---------	--	--	--

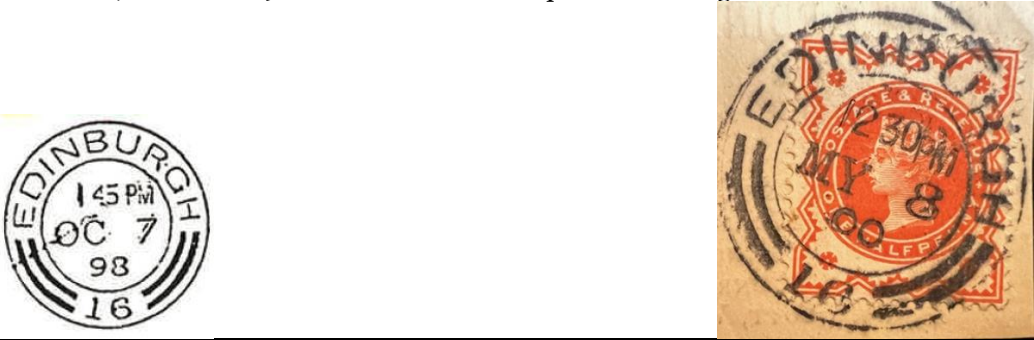
16.3.2	302	New case 7 October 1898 28 mm diameter – squatter lettering thinner arcs	
--------	-----	--	--

16.3.3	303	New case from 14 June 1900 – 29 mm, small numerals  repeated in Kirkwood's proof Book. I have not seen it.	
--------	-----	--	---

16.3.4	304	New case 4 August 1903 - 28 mm diameter – larger numerals	
--------	-----	---	--

16.3.5	305	Repaired 12 February 1909 – smaller lettering and arcs	
--------	-----	--	--

16.3.5.1		Change dating system - January 1, 1914	
17 JU 14			

16.3.6	306	New case 21 October 1914 28 mm – sharp ends to arcs	<p>I have no example</p>
--------	-----	---	--------------------------

16.3.7	307 <sup>16</sup>	New case 29 June 1916 – 28 mm diameter – shaped ends to arcs	<p>I have no example</p>
--------	-------------------	--	--------------------------

16.3.8	308 <sup>17</sup>	New case 6 March 1917 – 28 mm diameter – thinner arcs with shaped ends	
Used 1 JY 20			

<sup>16</sup> I doubt it is a new stamp





<sup>17</sup> I doubt it is a new stamp



# Stampers number 17

## Type 1

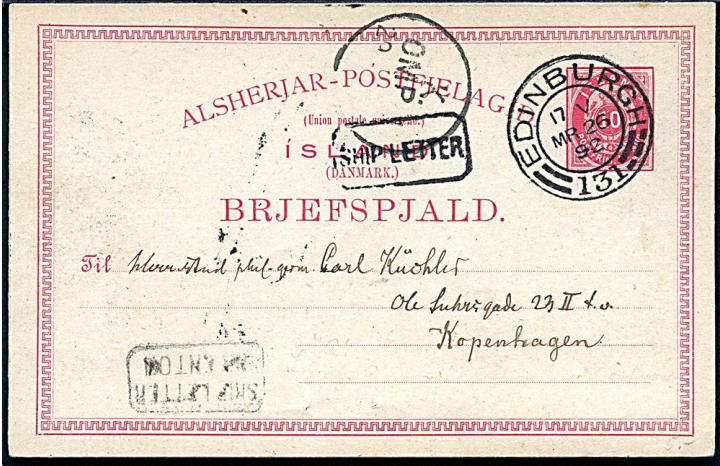
17.1.1	2	 <p>Proof</p>
--------	---	--

17.1.2	<p>With bar cut – Aitchison/Robin Morton: Recorded use 31. December 1891 – 13. December 1894. The first proof known is from NO 10 1893</p>  <p>- but used before</p>   <p>It might be number 24 proof changed to 17 – see the two barcut in the lower right bar</p>  <p>Number 24 should not exist per Auckland. Robin Morton shows a drawing with no other information than “24 M” as the proof. Seen in 1894 without time-letter after 17.</p>
--------	--

## Type 2

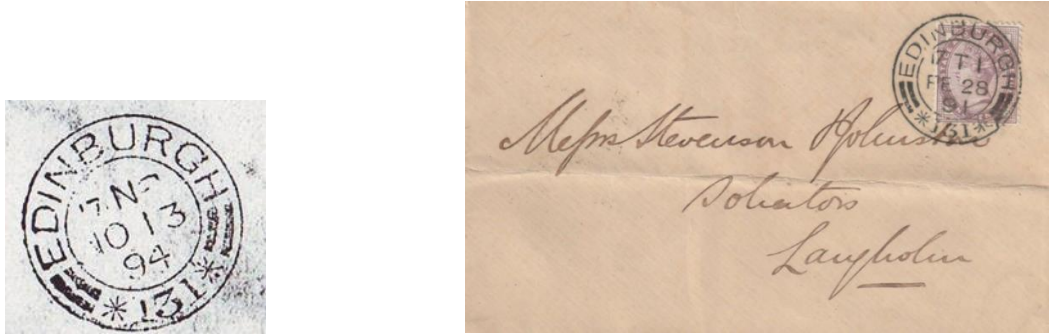

17.2.1		 <p>Proof - November 1894</p>
--------	--	---

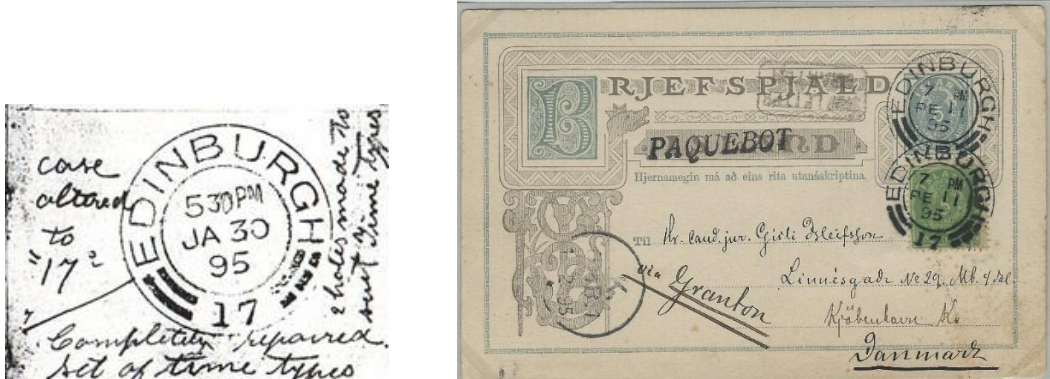

## Type 3

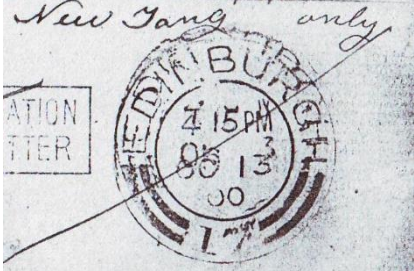

17.3.1	309	<p>Converted to clock time 30 January 1895 - 2 "cuts" in right outer arcs</p>  <p>Aitchison/Robin Morton: Recorded use including 17.3.2 from 11 February 1895 to 15 September 1896 The outer ring at the bottom disappears after a short time</p>
--------	-----	--

17.3.2	310	<p>Repaired 19 February 1896 - 2 "cuts" in right outer arcs - narrower numerals</p> 
--------	-----	--

17.3.3	311	New case from 16 November 1896 – 27 mm diameter	 
--------	-----	---	--

17.3.4	312	<p>New case from 12 May 1900 – 30 mm diameter</p>   <p>Kirkwood October 13 00</p>	 
--------	-----	--	---

17.3.5	313	New case from 9 April 1903 – 27 mm diameter	 
--------	-----	---	--

17.3.6	314	New case from 14 April 1905 – 28 mm diameter	 
--------	-----	--	---

17.3.7	315	New case from 12 March 1907 -24 mm diameter  I have no examples
--------	-----	--

17.3.8	316	New case from 24 September 1907 – 25 mm diameter. The “E” is at the middle of the date.   
--------	-----	--

17.3.8.1		Change dating system – 1 January 1914 
----------	--	---

17.3.9	317	New case from 20 July 1914 - 26 mm diameter – old date system. The “E” is at level with or a bit under the date  I have no examples
--------	-----	--

17.3.10		New case – 27 mm – new date system – used in MY 17 and until end twenties – example from 1926. The “E” is in the upper part of the date. 
---------	--	--

# Stampers number 18

## Type 1

18.1.1		I have not seen it either as proof or real
18.1.2		I have not seen it either as proof or real
18.1.3		It doesn't exist

## Type 2

18.2		It doesn't exist
------	--	------------------

## Type 3

18.3.1	318	Issued 22 October 1897 27 mm diameter	 
18.3.2	319	New case from 15 October 1901 – 30 mm diameter	 
18.3.3	320	New case from 3 August 1904 – 27 mm diameter	 

18.3.4	321	New case from 22 May 1908 – 27 mm diameter – small numerals	
--------	-----	---	--

18.3.4.1		Change dating system – 1 January 1914?	
----------	--	--	---

18.3.5	322	New case from 24 October 1917 – 26 mm diameter	
--------	-----	--	--

18.3.6	323	New case from 28 January 1930 – 25 mm diameter	
--------	-----	--	--

# Stampers number 19

## Type 1



19.1.1		I have not seen it either as proof or real
19.1.2		I have not seen it either as proof or real
19.1.3		It doesn't exist

## Type 2



19.2		It doesn't exist
------	--	------------------

## Type 3



19.3.1	324	Issued 22 October 1897 – 28 mm diameter
--------	-----	---











19.3.2	325	New case from 9 January 1901 – 30 mm diameter
--------	-----	---

19.3.3	326	Repaired 19 March 1904 – taller, narrower lettering, closer arcs
--------	-----	--

19.4	327	<p>New case from 30 October 1908 – 26 mm diameter</p> 	
19.3.5	328	<p>New case from 14 September 1911 – 28 mm diameter</p> 	
19.3.5.1		<p>Change dating system – 1 January 1914?</p>	
19.3.6		<p>New case from February 1918 – 26 mm diameter</p>  <p>I have no example</p>	
19.3.6.1	329	<p>This stamp was used as a "special" at the Royal Highland Show in June 1931 with the initials *H S' (Highland Show) above the date in the clock time. By that time the stamp was badly worn and the outer rim was all missing. Almost for sure not used on mail from Iceland.</p>  <p>I have no example</p>	



# Stampers number 20



## Type 1

20.1.1		I have not seen it either as proof or real
20.1.2		I have not seen it either as proof or real
20.1.3		It doesn't exist



## Type 2

20.2		It doesn't exist
------	--	------------------

## Type 3

20.3.1	330	Issued 2 May 1899 - 28 mm diameter	 
--------	-----	------------------------------------	--

20.3.2	331	Repaired 30 October 1900 – smaller lettering and numerals, thinner arcs	 <p>I have no examples</p>
--------	-----	---	---

20.3.3.1	332	New case from 29 July 1901 – 29 mm diameter – larger serif month and day slugs. It starts with a full ring, but it disappears and from 1902 (20.3.3.2) up to September 1908 (including 20.3.5). It looks like the repairs in 1902 and 1906 were not successful.	 
----------	-----	---	---

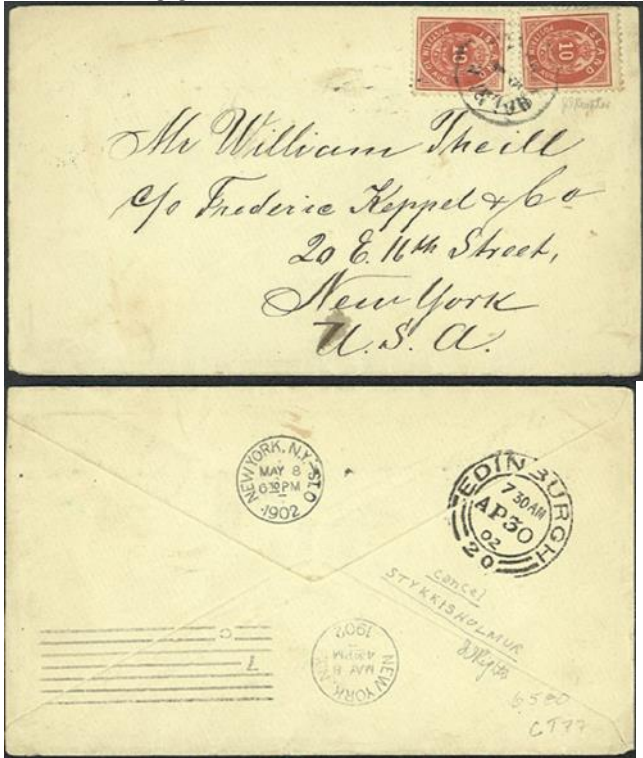
20.3.3.2		<p>The lower part of the ring dissapears – see 20.3.3.1</p> 
----------	--	---

20.3.4	333	<p>Repaired 10 July 1903 – thicker arcs It starts with a thin outer ring. The ring is gone in March 1904</p> 
--------	-----	---

20.3.5	334	Repaired 13 June 1906 – squatter lettering and numerals In August 1908 the ring is damaged	
--------	-----	---	--



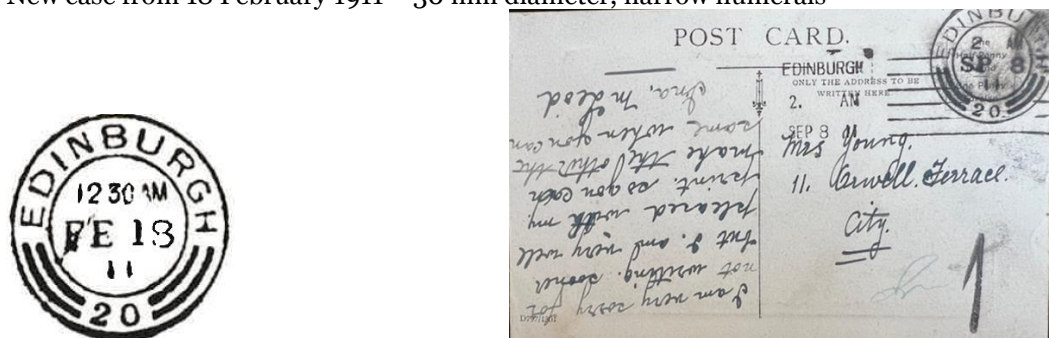

20.3.6	335	Repaired 19 September 1908 – narrower lettering widely spaced, smaller numerals	
--------	-----	---	---

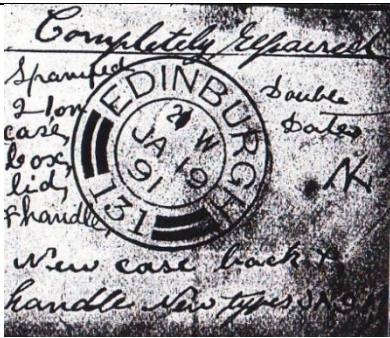

20.3.7	336	New case from 18 February 1911 – 30 mm diameter, narrow numerals	
--------	-----	--	--

20.3.7.1		Change dating system – 1 January 1914	
----------	--	---------------------------------------	---

# Stampers number 21

## Type 1

21.1.1		I have not seen it either as proof or real
21.1.2.1		<p><i>New case Tang &amp; handle 74 types Cleaned</i></p>  <p>I have no copy</p>
21.1.2.2		<p><i>Completely repaired</i></p>  <p><i>Stamped 2 low case, box, lid, &amp; handle</i></p> <p><i>Double dates</i></p> <p><i>New case back &amp; handle. New types</i></p> <p>I have no copy</p>
21.1.3		<p>Bar cut Aitchison/Robin Morton: Recorded use 30 November 1891- 12 December 1894 – but the proof is SP 15 91 and I have OC 2 91</p> <div style="display: flex; justify-content: space-around;"> <div data-bbox="375 1198 774 1467">  <p><i>resoftened &amp; line altered</i></p> <p>Proof</p> </div> <div data-bbox="957 1176 1420 1467">  <p>Example MY 18 94</p> </div> </div> 

21.1.3.1		<p>Known without the letter for the time in February and July 1892 (month and day in antique letter) and February 1893</p> <div style="display: flex; justify-content: space-around; align-items: center;">   </div>
----------	--	---

21.1.3.2		<p>Broken inner ring in 1894</p> <div style="text-align: right;">  </div>
----------	--	---

**Type 2**

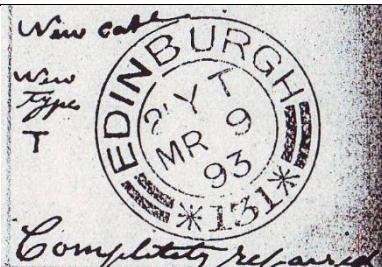
21.2		<div style="display: flex; align-items: center;">  <div style="margin-left: 10px;"> <p><i>Waw case</i></p> <p><i>Waw Type</i></p> <p><i>T</i></p> <p><i>Completely repaired</i></p> </div> </div> <p>Proof Per Auckland, A. Bruce it doesn't exist?</p>
------	--	--

**Type 3**

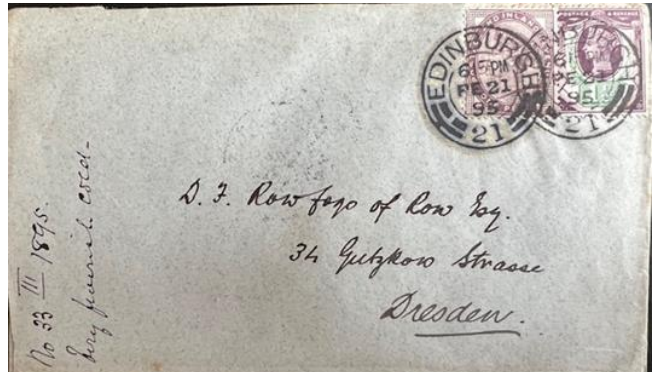
21.3.1	337	<p>Converted to hour and minutes 31.1.1895. "Cut" i left inner arc Aitchison/Robin Morton: Recorded use 2 May 1895 – 29 June 1896 (but also known FE 21 95 and JY 16 96)</p> <div style="display: flex; justify-content: space-between;"> <div style="width: 45%;">  <p><i>2 holes made to suit time type</i></p> <p><i>Case repaired set of time types</i></p> <p><i>case altered to '21'</i></p> </div> <div style="width: 45%;">  <p><i>No 33 III 1895</i></p> <p><i>big journal case</i></p> <p><i>D. F. Row fore of Row Sq.</i></p> <p><i>34 Gutzkow Strasse</i></p> <p><i>Dresden.</i></p> </div> </div>
--------	-----	---

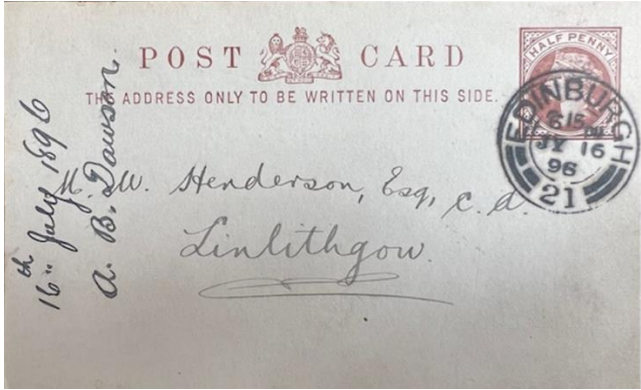
		<p>The last</p> 
--	--	--

21.3.1.1		<p>Different letters for the date – antique - JU 10 95 and JY 16 96</p> 
----------	--	---

End Bar Cut

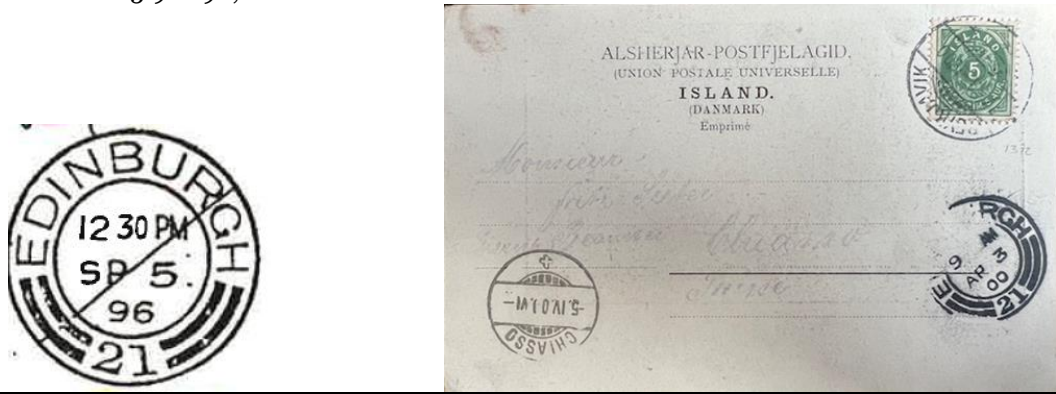
21.3.2	338	<p>New case 5.9.1896; 28 mm diameter</p> 
--------	-----	---

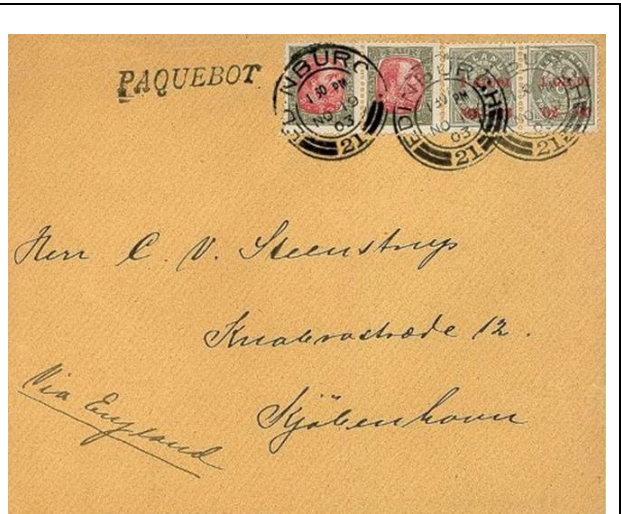
21.3.3	339	New case 2.5.1901; 29 mm diameter	
--------	-----	-----------------------------------	--



21.3.4	340	Repaired 1.9.1904 – narrower lettering	
--------	-----	--	---





21.3.5	341	<p>Mackay state: "new case app. December 1912"- but it is January 1911.          26 mm diameter.          Gunn show an example from 12.09.14 and indicate the start to app. 12.1912          No proof – not in Kirkwood</p>
--------	-----	---

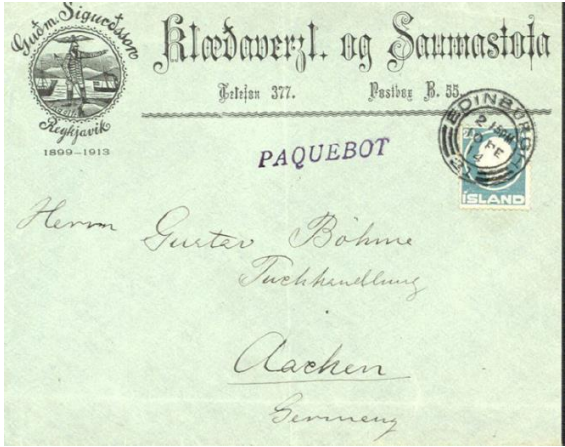

21.3.5.1		<p>Change dating system – 1 January 1914</p>
----------	--	--



21.3.6		<p>It is in the end rather used and the ink fill out between the frame and the outer right arc.</p> <p></p> <p></p> <p>*start date unknown – not in Kirkwood</p>
--------	--	--



# Stampers number 22

## Type 1

22.1.1		I have not seen it either as proof or real
22.1.2.1		Proof – I have not seen it and probably not used
22.1.2.2		

22.1.3		It doesnt exist
--------	--	-----------------

## Type 2

22.2		It doesn't exist
------	--	------------------

## Type 3

22.3.1	342	Issued 24.11.1902; 28 mm diameter	
--------	-----	-----------------------------------	--

22.3.2	343	New case 12.1.1906; 29 mm diameter	
--------	-----	------------------------------------	---

22.3.3	344	New case from app. 1912-1913 (after JU 26 12 - the latest example of no # 343); 24 mm diameter	
--------	-----	--	---

22.3.3.1		Change dating system – 1 January 1914	
----------	--	---------------------------------------	---



<sup>18</sup> The \* in Mackay's drawing show, that it is not found in Kirkwood

# Stampers number 23

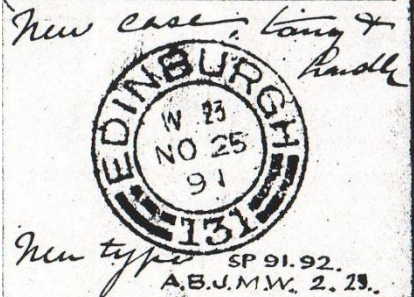
## Type 1

23.1.1		I have not seen it either as proof or real
23.1.2		I have not seen it – but look at 23.1.3.1
23.1.3.1		 <p>Proof</p> <p>If one look carefully at the upper left bar it looks like there are two cuts. Per Auckland, A. Bruce it was January 1892 “23” was changed to “6” but I am not shure – see # 6 The time and number is different (W 23)</p>

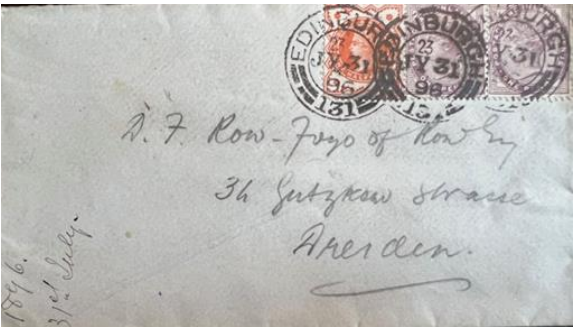
23.1.3.2		 <p>Auckland example</p> <p>It might be 23.1.2 with bar cut – but then only used in 1-2 months Aitchison/Robin Morton: Recorded use 11 December 1891 – 29 April 1892</p>
----------	--	--



23.1.3.3		<p>There are new type in Kitkwood, and all are without time letter:</p>   <p>Proof with bar cut – like 3.1.3 and used already JY 31 96., see Robin Morton. Aitchison/Robin Morton: Recorded use 7 October 1896 to 1 July 1898</p>  <p>And the year after another proof – but unchanged.</p>
----------	--	---



23.1.3.4		<p>At the end of 1898 it is worn and “23” is difficult to read and the date is broken and in smaller letters. I havn’t seen use in 1899 or later.</p> 
----------	--	---

**Type 2**

23.2		It don't exist
------	--	----------------

**Type 3**

23.3.1	345	<p>Issued 24.11.1902; 29 mm diameter</p>   <p>Late examples MY 19 07</p>
--------	-----	---

23.3.2	346	<p>New case 27.9.1907; 25 mm diameter</p>  
--------	-----	---

23.3.2.1.		<p>Change dating system – 1 January 1914 – seen 14 JA 15</p>  <p>Circle 25mm</p>
-----------	--	--

# Stampers number 24

## Type 1



24.1.1		I have not seen it either as proof or real
24.1.2		I have not seen it either as proof or real
24.1.3		 <p>Proof from Kirkwood. Auckland state, that it doesn't exist. It looks like the later number 17 with two cuts in the lower right bar. Robin Morton shows a drawing with no other information than "24 M"</p>

## Type 2

		It doesn't exist
--	--	------------------

## Type 3

24.3.1	347	Issued 24.11.1902; 28 mm diameter
		

23.3.2	348	New case 31.1.1907; 26 mm diameter
 		

23.3.3.	349	<p>New case from app. 1912-1913; 25 mm diameter – fat arcs from May 1913?</p> <div style="display: flex; align-items: center;">  <div style="margin-left: 20px;"> <p>* (Not in Kirkwood)</p> </div> </div> <div style="display: flex; align-items: center; margin-top: 20px;">  <div style="margin-left: 20px;">  </div> </div>
---------	-----	---

24.3.3.1	<p>Change dating system – 1 January 1914? I have not seen it</p>
----------	--

# Stampers number 25

## Type 1

25.1.1		I have not seen it either as proof or real
25.1.2		I have not seen it either as proof or real
25.1.3		It doesn't exist



## Type 2

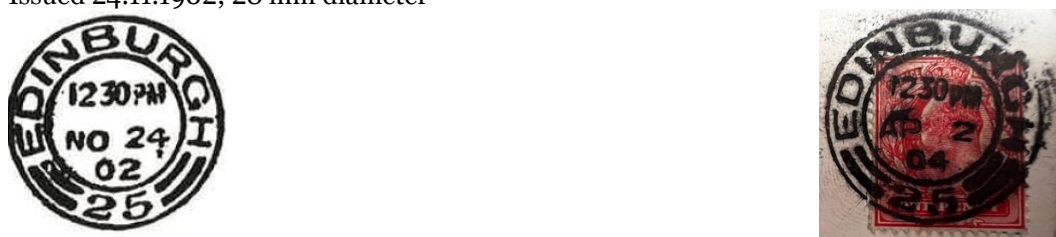

25.2		It doesn't exist
------	--	------------------

## Type 3

25.3.1	350	Issued 24.11.1902; 28 mm diameter	
--------	-----	-----------------------------------	--

25.3.2	351	Repaired 8.4.1904; shorter, thicker arcs. Small differences in "25". 30 mm diameter.	
--------	-----	--	---

25.3.3	352	New case 28.2.1908; 25 mm diameter.		
--------	-----	-------------------------------------	---	---

25.3.4	353	New case 19.1.1911;		
--------	-----	---------------------	---	--

25.3.4.1		Change dating system – 1 January 1914	
----------	--	---------------------------------------	---

**Here there is a gap – no # 26 to # 30 are missing.  
Why is unknown**



## Stampers number 31

I have not seen it used on Icelandic mail.

I don't know the reason.

### Type 1

31.1.1		I have not seen it either as proof or real
31.1.2		I have not seen it either as proof or real
31.1.3		It doesn't exist

### Type 2

31.2		It doesn't exist
------	--	------------------

### Type 3

31.3.1	354	Issued 19.1.1894 with indices; 27 mm diameter	
--------	-----	---	---

31.3.2	355	Changed to hours and minutes 10.1.1895	
--------	-----	--	--

31.3.3	356	New case 2.2.1899; 29 mm diameter	
--------	-----	-----------------------------------	--

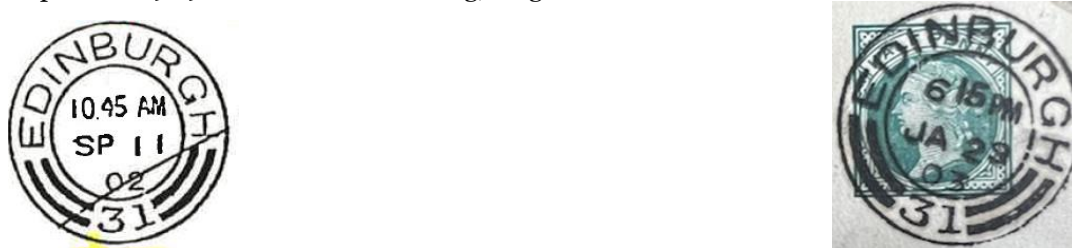
31.3.4	357	Repaired 11.9.1902 – narrower lettering, longer arcs	
--------	-----	--	--

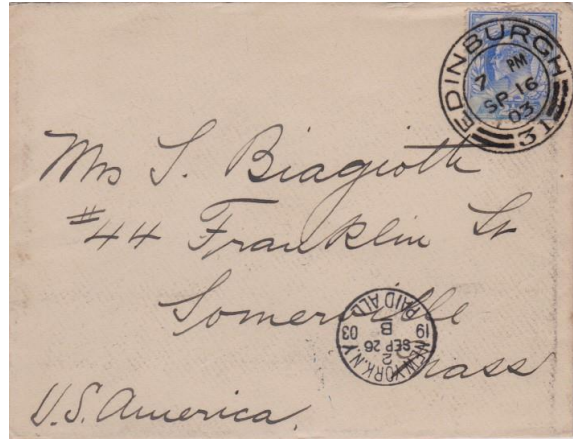
31.3.5	358	Repaired 14.9.1903 – broader lettering, shorter arcs  	
--------	-----	--	---

Quite new

31.3.6	359	New case 20.11.1908; 25 mm diameter  
--------	-----	--

I don't have an example

31.3.6.1	Change dating system – 1 January 1914?? I haven't seen it
----------	--

# Stampers number 32



## Type 1



32.1.1		I have not seen it either as proof or real
32.1.2		I have not seen it either as proof or real
23.1.3		It doesn't exist

## Type 2

32.2		Per the text in the proof book and by Mackay to the first type 3: "Changed" *131*-stamp" fitted with indices 30.9.1894" there must have been one – but I have not seen it (see Makcay "Scottish Postmarks" page 53. Per Auckland, A. Bruce: it doesn't exist.
------	--	---



## Type 3

32.3.1	360	<p>Changed "131*-stamp" fitted with indices 30.9.1894</p>  <p>Shoulder of dates &amp; months adjusted to suit the new types 2 Double Types *A*P</p>  <p>63.</p> <p>Another proof 1894</p> <p>Proof Not seen until the version 32.3.2 – and it has probably not been issued except as proof.</p>
--------	-----	--

32.3.2	361	<p>Changed to hour and minutes 14.1.1895</p>  <p>18. Line types</p> <p>"32" is placed a bit to the right</p>  <p>POST CARD THE ADDRESS ONLY TO BE WRITTEN ON THIS SIDE</p> <p>D. A. Dalmarby 12 Hill Street</p>
--------	-----	--

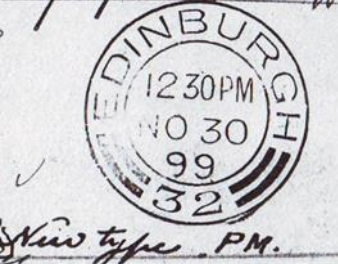
32.3.3	362	Repaired 28.6.1897 – broader lettering, closer arcs  <p>I don't have an example</p>
--------	-----	---

32.3.4	363	Repaired 15.2.1899; shorter arcs Kirkwood "New type - PM" NO 30 99. I only have examples after NO 99 and I can't see the difference between FE and NO 1899.   <p><i>New type PM.</i></p>
--------	-----	--

32.3.5	364	Repaired 1.6.1904 – letters "E, B og R" renewed – thicker arcs   <p>Comment allegé: Had.  <b>POST CARD.</b>          ONLY THE ADDRESS TO BE WRITTEN HERE  <i>Miss Hogg,          Brock Cottage          East Village          Aberdeen</i></p>
--------	-----	--

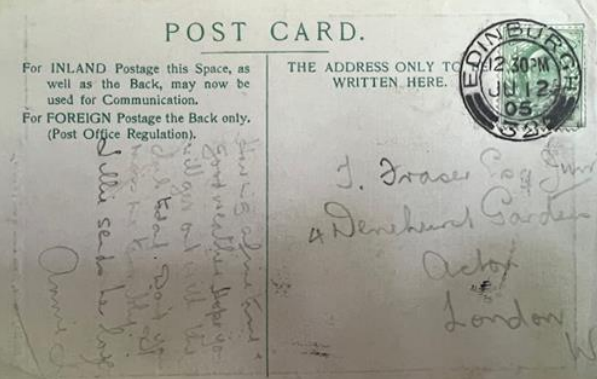
32.3.6	365	Repaired 21.4.1905 – narrower letters "G" and "H"   <p><b>POST CARD.</b>          For INLAND Postage this Space, as well as the Back, may now be used for Communication.          For FOREIGN Postage the Back only. (Post Office Regulation).          THE ADDRESS ONLY TO BE WRITTEN HERE.  <i>J. Fraser Esq          4 Denehurst Garden          Acton          London W</i></p>
--------	-----	---

32.3.7	366	New case 14.5.1906; 25 mm diameter	
--------	-----	------------------------------------	--

32.3.8	367	New case 14.5.1907; 26 mm diameter – broader lettering and numerals	
--------	-----	---	--



32.3.9	368	New case 11.2.1909; 26 mm diameter – smaller lettering	
--------	-----	--	--



32.3.10	369	New case 14.7.1911; 25 mm diameter – long arcs	
---------	-----	--	--

32.3.10. 1		Change dating system – 1 January 1914 - ? Only 19 days? Not seen	
---------------	--	---	--

32.3.11	370	New case 19.1 1914; 26 mm diameter – thin arcs widely numerals	
---------	-----	--	---

32.3.12	371	New case 15.4.1916; smaller numerals		No examples
---------	-----	--------------------------------------	---	-------------

32.3.13	372	New case 15.5.1917; 27 mm diameter, small lettering widely spaces		
---------	-----	---	---	---

32.3.14	373	New case 13.3.1919; 25 mm diameter, small numerals		
---------	-----	--	---	--

# Stampers number 33

## Type 1

33.1.1		I have not seen it either as proof or real
33.1.2		I have not seen it either as proof or real
33.1.3		It doesn't exist



## Type 2

33.2		Per the text by Mackay to the first type 3, there must have been one – but I have not seen it. Per Auckland, A. Bruce it doesn't exist
------	--	--

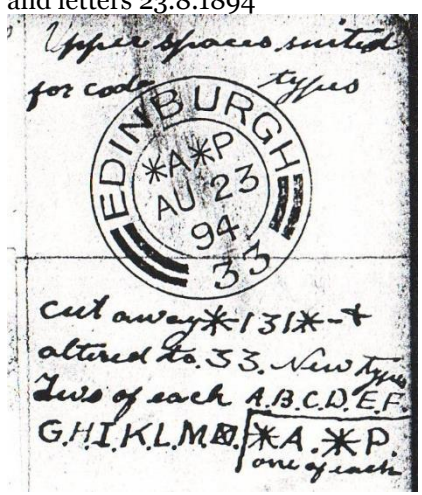

## Type 3



33.3.1	374	<p>The first type 3 is an converted "*131*-stamp" - Converted "*131*-stamp" with *'s and letters 23.8.1894</p>  <p>Probably not issued before 33.3.2 – same space around “33”</p>
--------	-----	---

33.3.2	375	<p>Changed to hours and minutes 17.1.1895</p>  <p>From 1896 the second 3 has a “fallen” top:</p>
--------	-----	--

33-3-3	376	Repaired 23.5.1904  The date is "wrong" – 23 MY instead of MY 23	
--------	-----	--	--

33-3-4	377	Repaired 30.5.1905  	
--------	-----	---	--

33-3-5	378	Repaired 1.8.1908 	
--------	-----	--	---

33-3-6	379	New case 1.2.1909 	
--------	-----	--	---



33.3.6.1      Change dating system – 1 January 1914 ?? New 2 MR 14

33.3.7	380	New case 2.3.1914	
--------	-----	-------------------	--

33.3.8		In 1919 the figure for the year is smaller	
--------	--	--	--

33.3.9		In 1929 even smaller	
--------	--	----------------------	--

# Stampers number 34





## Type 1

34.1.1		I have not seen it either as proof or real
34.1.2		I have not seen it either as proof or real
34.1.3		It doesn't exist

## Type 2

34.2		I have not seen it as either proof or real – but 34.3.1 say in the proof book: "repaired"? Per Auckland, A. Bruce it doesn't exist
------	--	---

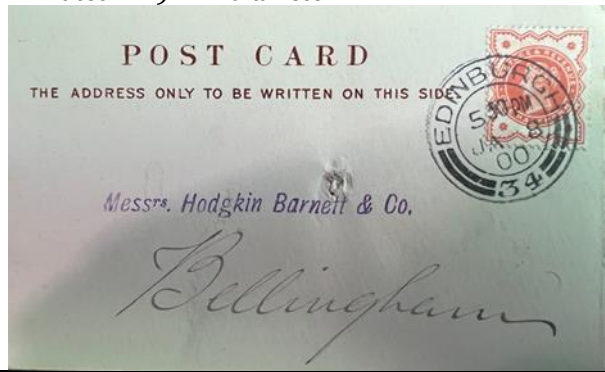
## Type 3

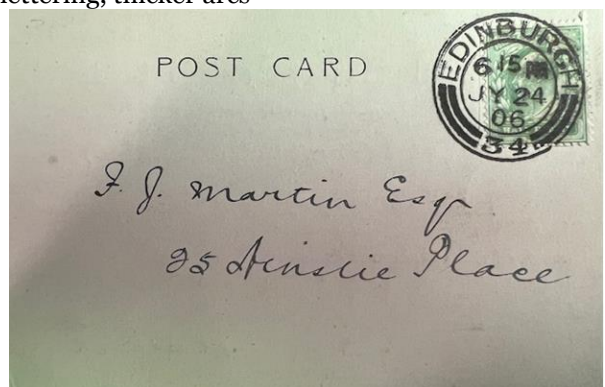
34.3.1	381	<p>Issue 5.9.1894</p>  <p><i>New case Tang &amp; handle 20 New check Types 2 Double Types *A*P Old Types beat up &amp; repaired. Box lid stamped 34.</i></p>  <p>Kirkwood 1894 page 538 - Probably not issued before 34.3.2</p>
34.3.2	382	<p>New case 18.1.1895 – hour and minutes – 29 mm diameter</p>  
34.3.3	383	<p>Repaired 31.5.1904; narrower lettering, thicker arcs</p>  





34.3.4	384	<p>New case 26.11.1908; 30 mm diameter</p>   
--------	-----	--

34.3.4.1	Change dating system – 1 January 1914?
----------	--

**There are no further numbers, but:**

**No number - but "cut"**

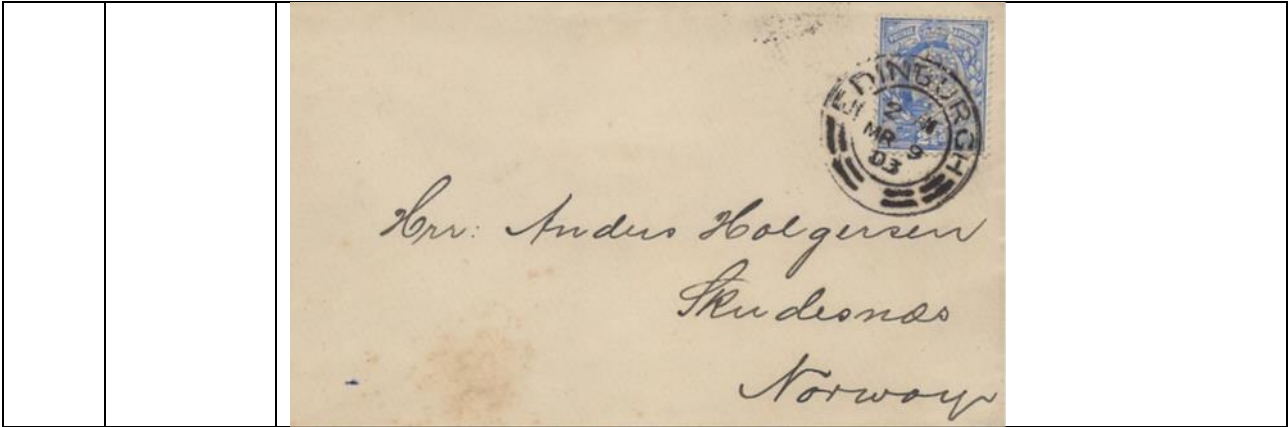

See IslandsKontakt SPECIAL # 20 A for further.

<p>35.3.1</p>	<p>385</p>	<p>"Cut" in all for arcs – in use by 12.1900</p>  <p style="text-align: center;">*</p> <p>In Kirkwood proof book there is an unclear proof from 1901.</p>  <p>In Mackay's "Scottish Postmarks" # 532 he shows "2 AM SP 25 02". See also Robin Morton: "The postmark Post" 2012 no. 132 page 12</p>  <p>It can be related to Stuart R MacKenzie in "The postmark Post" 2019 no. 160 page 13 also showing "2 AM" from SP 20 01 and JY 10 03. I have "2 AM SP 12 02" and they all look like 35.3.1?</p>
<p>35.3.2</p>	<p>386</p>	<p>Repaired and recut 16.12.1902– thinner arcs</p>   <p>As seen – it is not a "2 AM" example as indicated by Robin Morton and Stuart R MacKenzie – but I have not seen it used. This copy is a "2 AM" example.</p>





# No number – no "cut"

See IslandsKontakt SPECIAL # 20 C for further.

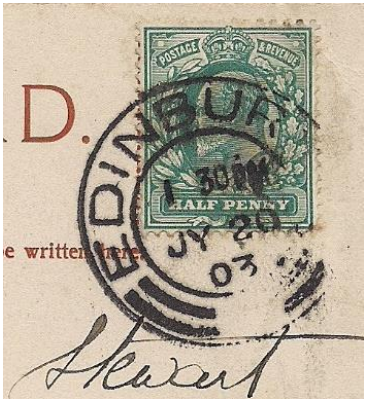
36.3.1	387	<p>In use by 12.1899; 27 mm diameter – wide space between arcs</p> <div style="display: flex; justify-content: space-around; align-items: center;">   </div> <p><b>In use by 12.1899: 27mm diameter, wide space between arcs (387)</b>          This was actually in use by August 1899.          23 Aug 99 2 AM Envelope to Switzerland Wednesday          22 Sep 99 2 AM Envelope piece Friday          06 Nov 99 2 AM Envelope to Germany Monday  <b>14 Dec 99 7 PM</b> Envelope to Golspie Thursday          27 May 01 2 AM Postcard piece Monday</p>
--------	-----	--



		<p><b>?? Unlisted type; 30mm diameter</b></p> <div style="text-align: right;">  </div> <p><b>20 Jul 03 1 30 PM</b> Postcard to Dundee Monday (<b>unlisted</b>)</p>
--	--	--

<sup>19</sup> The \* in Mackay's drawing show, that it is not found in Kirkwood.

36.3.2	388	<p>In use 8.1905; 28 mm diameter – narrow space between arcs. Gunn shows AP 11 04</p> <div style="display: flex; justify-content: space-around; align-items: flex-start;"> <div style="text-align: center;">  <p>*20</p> </div> <div style="text-align: center;">  </div> </div> <p>Sub-type 1 (#) The stamper code part of the double arc appears to be made up of a separate slug from the rest of the double arc.</p> <div style="text-align: center; margin-top: 20px;">  </div> <p>Sub-type 2 No separate part for stamper code portion.</p> <p><b>In use by 08.1905: 28mm diameter, narrow space between arcs (388)</b></p> <p>There were actually two separate sub-types within type 388, with different letterings of “EDINBURGH” and different characteristics of the missing stamper code element as shown in the following table:</p> <p>04 Mar 04 2 AM # Postcard to Edinburgh Friday  29 Jul 04 2 AM # Postcard to Perth Friday  18 Aug 04 2 AM # Postcard to Eastbourne Thursday  15 Mar 05 2 AM # Postcard to Lincolnshire Wednesday  02 Oct 05 2 AM # Postcard to Surrey Monday  <b>13 Jan 08 8 PM</b> Postcard to Falkirk Monday</p>
--------	-----	--

36.3.2.1		Change dating system – 1 January 1914 ??
36.3.4	390	<p>New case 30.4.1915; 25 mm diameter – small lettering, thin arcs No copies held</p> <div style="text-align: center; margin-top: 20px;">  </div>





<sup>20</sup> The \* in Mackay’s drawing show, that it is not found in Kirkwood.

36.3.5	389	<p>In use by 12.1915; 26mm diameter, wide space between arcs  No copies held  26 mm diameter, wide space between arcs</p> 
36.3.6.	391	<p>New case 16.6.1919; 26 mm diameter – fitted with RP slugs for use on registered parcels  No copies held</p> 

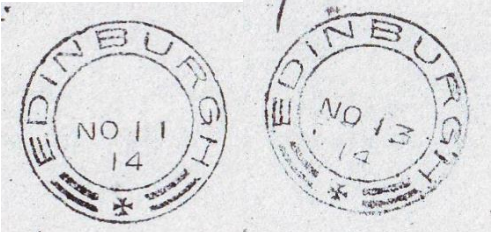

# Cross pattée

See IslandsKontakt SPECIAL # 20 B and/or Iceland Philatelic Magazine # 62 page 6 for further

37.1		<p>JU 28 06</p> 
37.2		<p>NO 2 08</p>  <p><i>Edinburgh (London Office) from ...</i></p> <p>This proof is hard to read and examples hard to find.</p> <p>I have only registered use on few days – one perhaps before the proof JU 28 06 and 8 after: - NO 11 08 - AU 5 09 - SP 14 11 - OC 24 12 - NO 19 12 - FE 15 13 - 20 AU 14 – and one after 1.1.1914. 5 from Iceland and 4 Scottish.</p>  <p>There are then proofs in Kirkwood from NO 11 14 and NO 13 14 (with old line-up with month first)</p> 
37.3		<p>New date system</p>  <p>From Kirkwood but without recorded use.</p>

## References:

- Aitchison, Ian M.; The Edinburgh Bar Cuts (Catalogue of the Edinburgh 77 Philatelic Exhibition)
- Auckland, A. Bruce; "The Edinburgh Bar Cuts" (Postal History Society Bulletin no. 142)
- Gunn, Jack A. and Alastair J; "Scottish combined date stamps with stampers' numbers – a postal history exhibit" (2012)
- Kirkwood's Proof Books 1829-1918 reproduced from the copies held by the Scottish Postal History Society
- Mackay, James A.; Scottish Twin-Arc Postmarks with Stampers' Number (1983)
- Mackay James A.; Scottish Postmarks (1978)
- Mackay James A.; Scottish Twin-arc Postmark with stampers number 1894::1963 (1983)
- MacKenzie, Stuart R; "The Scottish Post" 2019 no. 160 page 13-14
- Morton, Robin; "The Scottish Post" 2012 no. 132 page 12
- Morton, Robin and Arrevad, Jakob; "Edinburgh 2AM Bar cut", "The Scottish Post" 2019 no. 161 page 9-10
- Morton, Robin: The Bar Cut Postmarks of Edinburgh 1887-1904. The London Philatelists p. 477ff.
- Parkin, Stephen RH; "Edinburgh Double Bar cut" "The Scottish Post" 2019 no. 162 page 4-5